

FOR 26/44/62P

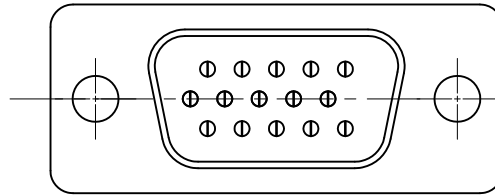
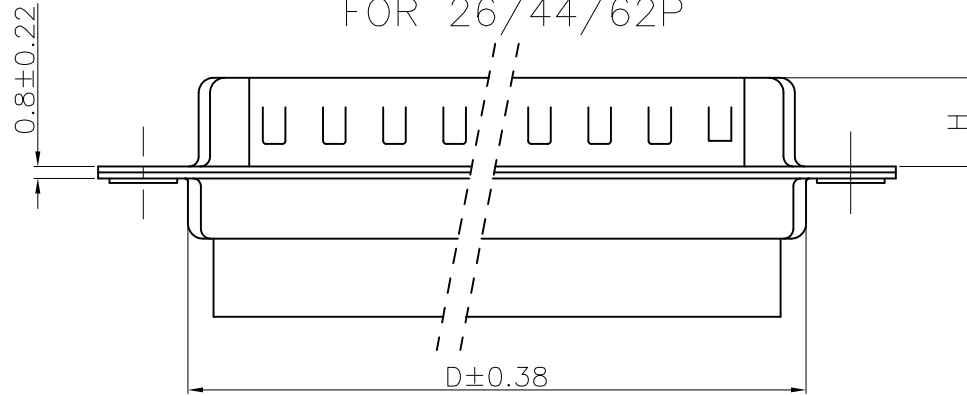

FOR 15P

REMARK:

- CHARACTERISTICS:
OPERATING TEMPERATURE RANGE: -55° C~105° C
- MATERIAL:
INSULATORS: THERMOPLASTIC G.F(UL94V-0) BLACK
SHELL: CARBON STEEL, 100u" Min NICKEL TIN TOP OVER,
50u" Min COPPER UNDER PLATE.
STOPPER: CARBON STEEL.
- PART NUMBER DESCRIPTION: **10090930-P XX X X LF**

SERIES NO.	LF: ROHS COMPLIANT
TYPE P: PIN (MALE)	FLANGE MOUNTING OPTION A: STANDARD HOLE
NUMBER OF CONTACTS	CONTACT FINISH 0: NO CONTACT
15: 15-PIN	
26: 26-PIN	
44: 44-PIN	
62: 62-PIN	

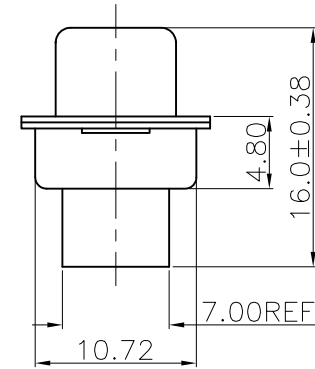

POS.	PART NO.	A	B	C	D	E	H
15	10090930-P150ALF	30.81	24.99	16.92	19.10	2.29	5.90 ^{+0.25} ₀
26	10090930-P260ALF	39.24	33.32	25.25	27.75	2.29	5.90 ^{+0.25} ₀
44	10090930-P440ALF	53.04	47.04	38.96	41.30	2.29	5.70 ^{+0.25} ₀
62	10090930-P620ALF	69.32	63.50	55.42	57.40	2.41	5.70 ^{+0.25} ₀

mat'l. code				tolerances unless otherwise specified				CUSTOMER COPY		FCI www.fciconnect.com	
ltr	ecn no	dr	date	linear		.X ± 0.38		projection		title	
A	T09-1157	J.H	12/10/09	angles		.XX ± 0.25		⊕		HDEC MALE CRIMPING	
						.XXX ± 0.10		MM		product family D-SUB	
				dr		0° ± 2°		scale		code	
				enr		JASON HSU 12/10/09		1:1		size	
				chr		GARY HSIEH 12/10/09		A4		10090930	
				appd		JOSEPH HSIA 12/10/09				sheet	
sheet index	revision sheet	A	A								1 of 2
		1	2								

Tous droits strictement réservés. Reproduction ou communication a des tiers interdite sous quelque forme que ce soit sans autorisation écrite du propriétaire. Propriete de c FCI. Droits de reproduction FCI.



All rights strictly reserved. Reproduction or issue to third parties in any form whatever is not permitted without written authority from the proprietor. Property of FCI. Copyright FCI.

1 | 2

3

4

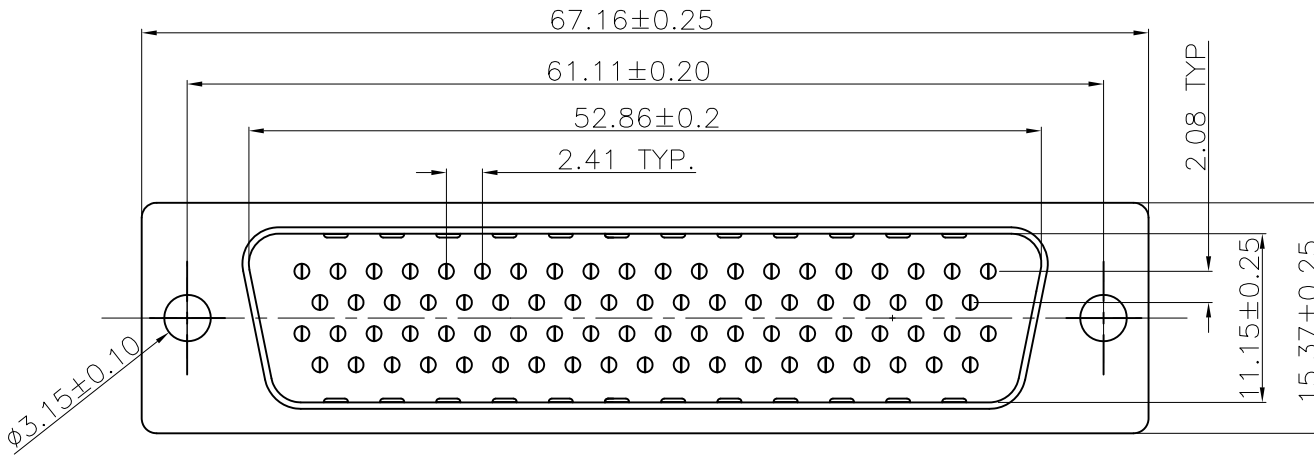

REMARK:

- CHARACTERISTICS:
OPERATING TEMPERATURE RANGE: -55° C~105° C
- MATERIAL:
INSULATORS: THERMOPLASTIC G. F(UL94V-0) BLACK
SHELL: CARBON STEEL, 100u" Min NICKEL TIN TOP OVER,
50u" Min COPPER UNDER PLATE.
STOPPER: CARBON STEEL.
- PART NUMBER DESCRIPTION: **10090930-P XX X X LF**

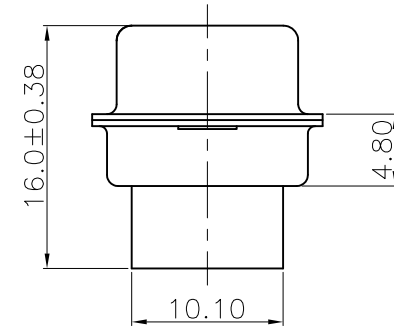
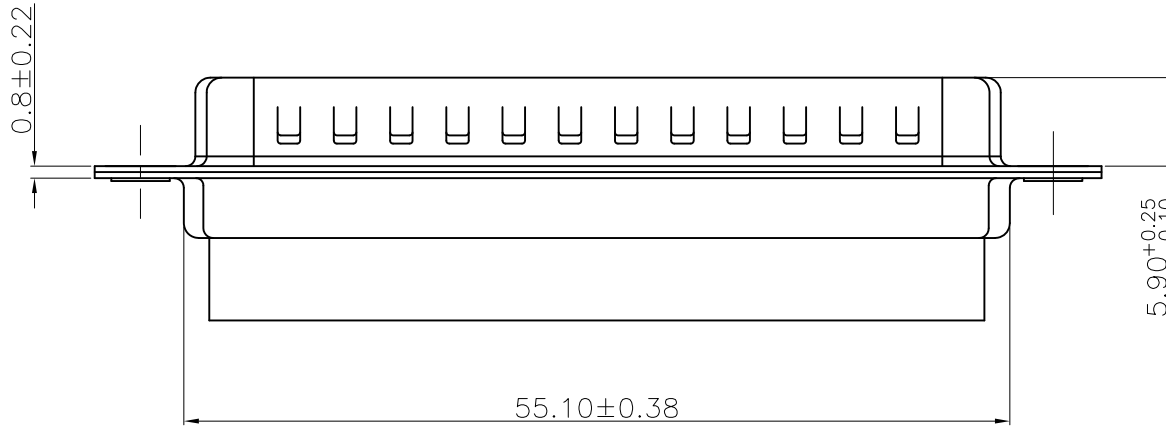
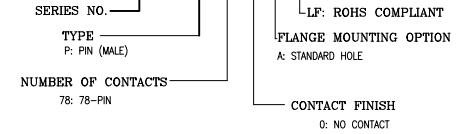

PART NO.: 10090930-P780ALF

mat'l. code				tolerances unless otherwise specified			CUSTOMER COPY		FCI www.fciconnect.com		
ltr	ecn no	dr	date	linear	.X ± 0.38		projection	title			
A					.XX ± 0.25			H78P	HDEC 78P MALE CRIMPING		
					.XXX ± 0.10				product family D-SUB		code
				angles	0° ±2°		MM	size dwg no		TWN	
				dr	JASON HSU	12/10/09	scale	10090930		sheet	
				enr	JASON HSU	12/10/09	1:1	A4		2 of 2	
				chr	GARY HSIEH	12/10/09					
				appd	JOSEPH HSIA	12/10/09					
sheet index	revision sheet										

1 | 2

3

4